

MAX4888B Evaluation Kit

Evaluates: MAX4888B

General Description

The MAX4888B evaluation kit (EV kit) provides a proven design to evaluate the MAX4888B dual double-pole/double-throw (2 x DPDT) switch. The device is ideal for switching two half-lanes of PCI Express® (PCIe) data between two possible destinations and supports up to 8.0Gbps data rate (Gen III PCIe). The EV kit is used for critical tests (i.e., eye diagrams and s-parameter measurements such as insertion loss, return loss, and off-isolation).

The EV kit PCB comes with a MAX4888BETI+ installed, which is available in a lead(Pb)-free, 28-pin (3.5mm x 5.5mm) TQFN package with an exposed pad. The EV kit circuit requires a 3.3V power supply capable of supplying at least 100mA.

Features

- ◆ Eye Diagram Test Circuit with SMA Input/Output
- ◆ SMA Connectors for Easy Data Interfacing
- ◆ Calibration Load and No Load Traces
- ◆ Proven PCB Layout
- ◆ Fully Assembled and Tested

[Ordering Information](#) appears at end of data sheet.

Component List

DESIGNATION	QTY	DESCRIPTION
C1, C2, C6, C8, C10	5	1 μ F \pm 10%, 6.3V X5R ceramic capacitors (0402) Murata GRM155R60J105K
C3, C4, C5, C7, C9	5	1000pF \pm 10%, 16V X5R ceramic capacitors (0402) Murata GRM155R61C102K
C11	1	10 μ F \pm 10%, 16V X5R ceramic capacitor (0805) Murata GRM21BR61C106K
C12–C15	4	0.22 μ F \pm 10%, 10V X5R ceramic capacitors (0402) Murata GRM155R61A224K

DESIGNATION	QTY	DESCRIPTION
JU1, JU2	2	3-pin headers
P1–P12	12	Edge-mount receptacle/SMA connectors
R1, R2	2	49.9 Ω \pm 1% resistors (0402)
U1	1	8.0Gbps dual passive switches (28 TQFN-EP) Maxim MAX4888BETI+
—	2	Shunts
—	1	PCB: MAX4888B EVALUATION KIT

Component Supplier

SUPPLIER	PHONE	WEBSITE
Murata Electronics North America, Inc.	770-436-1300	www.murata-northamerica.com

Note: Indicate that you are using the MAX4888B when contacting this component supplier.

PCI Express is a registered trademark of PCI-SIG Corp.

MAX4888B Evaluation Kit

Evaluates: MAX4888B

Quick Start

Required Equipment

- MAX4888B EV kit
- 3.3V, 100mA DC power supply
- Waveform generator with a data rate of at least 8.0Gbps (i.e., Tektronix AWG7122B)
- Digital serial analyzer sampling oscilloscope with a data rate of at least 8.0Gbps (i.e., Tektronix DSA72004B)
- Six equal-length SMA cables

Procedure

The EV kit is fully assembled and tested. Follow the steps below to verify board operation and eye diagram/jitter measurements. **Caution: Do not turn on the power until all connections are completed.**

- 1) Connect the DC power supply to the VCC and GND PCB pads on the EV kit.
- 2) Verify that jumper JU1 is in the 2-3 position and jumper JU2 is in the 1-2 position.
- 3) Set up the waveform generator for a bit rate of 8.0Gbps, $1V_{P-P}$ differentially, nonreturn-to-zero (NRZ) mode, and desired pseudorandom binary (bit) sequence (PRBS) with $2^{15}-1$ or 2^7-1 patterns.
- 4) Use a pair of SMA cables to connect the differential output signals of the waveform generator to the P5 (AOUTA+) and P6 (AOUTA-) SMA connectors on the EV kit.
- 5) Using a single SMA cable, connect the trigger input of the digital serial analyzer to the trigger output of the waveform generator.
- 6) Using a single SMA cable, connect the clock input of the pattern sync module of the digital serial analyzer to the clock output of the waveform generator.
- 7) Use the other pair of SMA cables to connect both sampling channels of the digital serial analyzer to the P1 (D_AIN+) and P2 (D_AIN-) SMA connectors on the EV kit.
- 8) Set the digital serial analyzer to infinite persistence and select the math function of the signal ((D_AIN+) - (D_AIN-)).
- 9) Adjust the digital serial analyzer vertical scale to 100mV/div and the horizontal scale to 200ps/div.
- 10) Turn on the DC power supply.
- 11) Enable the data and clock outputs on the waveform generator and observe the waveform on the digital serial analyzer.
- 12) Save the waveform on the digital serial analyzer.
- 13) Disable the data and clock outputs of the waveform generator.
- 14) Turn off the DC power supply.
- 15) Remove the pair of SMA cables connected to AOUTA+ and AOUTA- on the EV kit and connect the cables to the P9 (R_AOUT+) and P10 (R_AOUT-) SMA connectors on the EV kit.
- 16) Remove the pair of SMA cables connected to D_AIN+ and D_AIN- on the EV kit and connect the cables to the P7 (R_AIN+) and P8 (R_AIN-) SMA connectors on the EV kit.
- 17) Enable the data and clock outputs on the waveform generator and observe the waveform on the digital serial analyzer.
- 18) Compare the current waveform to the saved waveform and observe the jitter/eye height of both systems. Take the difference in jitter/eye height and that is the extra jitter/eye height coming from the device.

Detailed Description of Hardware

The MAX4888B EV kit provides a proven design to evaluate the MAX4888B PCIe Gen III 8.0Gbps passive switch. The device is a dual DPDT switch ideal for switching two half lanes of PCIe data between two destinations. The EV kit is used for critical tests (i.e., eye diagrams and s-parameter measurements such as insertion loss, return loss, and off-isolation).

For simplicity, only one channel of the device is used in the EV kit. Only the AIN_, AOUTA_, and AOUTB_ signals are used in the EV kit. All device output signal traces have 100Ω differential controlled-characteristic-impedance traces. Once the differential traces split into separate directions, the traces have 50Ω single-ended controlled-characteristic impedance, which is equivalent to 100Ω differentially.

The MAX4888B operates from a 3.0V to 3.6V supply that provides at least 1mA.

MAX4888B Evaluation Kit

Evaluates: MAX4888B

Calibration Trace

There are calibration traces on the bottom of the EV kit PCB that are used as a reference to differentiate the performance of the switch from the traces and the SMA connectors, providing a complete analysis of the device.

No Load

The first set of calibration traces are made with no load. The trace lengths are equal to the circuit with the device. The traces starting from R_AIN_ and R_AOUT_ have 50Ω single-ended controlled-characteristic impedance. Once the calibration PCB traces run parallel to each other and are matched side-by-side, the traces have 100Ω differential controlled-characteristic impedance.

Load

The second set of calibration traces are made with a 50Ω load. The lengths of these traces are half of the no-load calibration traces, as detailed in the *No Load* section.

SEL and SELB Jumper Selection

Table 1 shows the truth table for the device control signals. Use the truth table to switch D_AIN_ between AOUTA_ and AOUTB_. Jumper JU1 is used to drive the device's SEL signal and jumper JU2 is used to drive the SELB signal. When the jumpers are in the 1-2 position, the signals are high and when the jumpers are in the 2-3 position, the signals are low.

Table 1. SEL and SELB Jumper Description (JU1, JU2)

JU1 (SEL)	JU2 (SELB)	SWITCHES D_AIN_ TO AOUTA_	SWITCHES D_AIN_ TO AOUTB_
2-3*	2-3	Off	On
1-2	2-3	Off	On
2-3*	1-2*	On	Off
1-2	1-2*	Off	On

*Default settings.

MAX4888B Evaluation Kit

Evaluates: MAX4888B

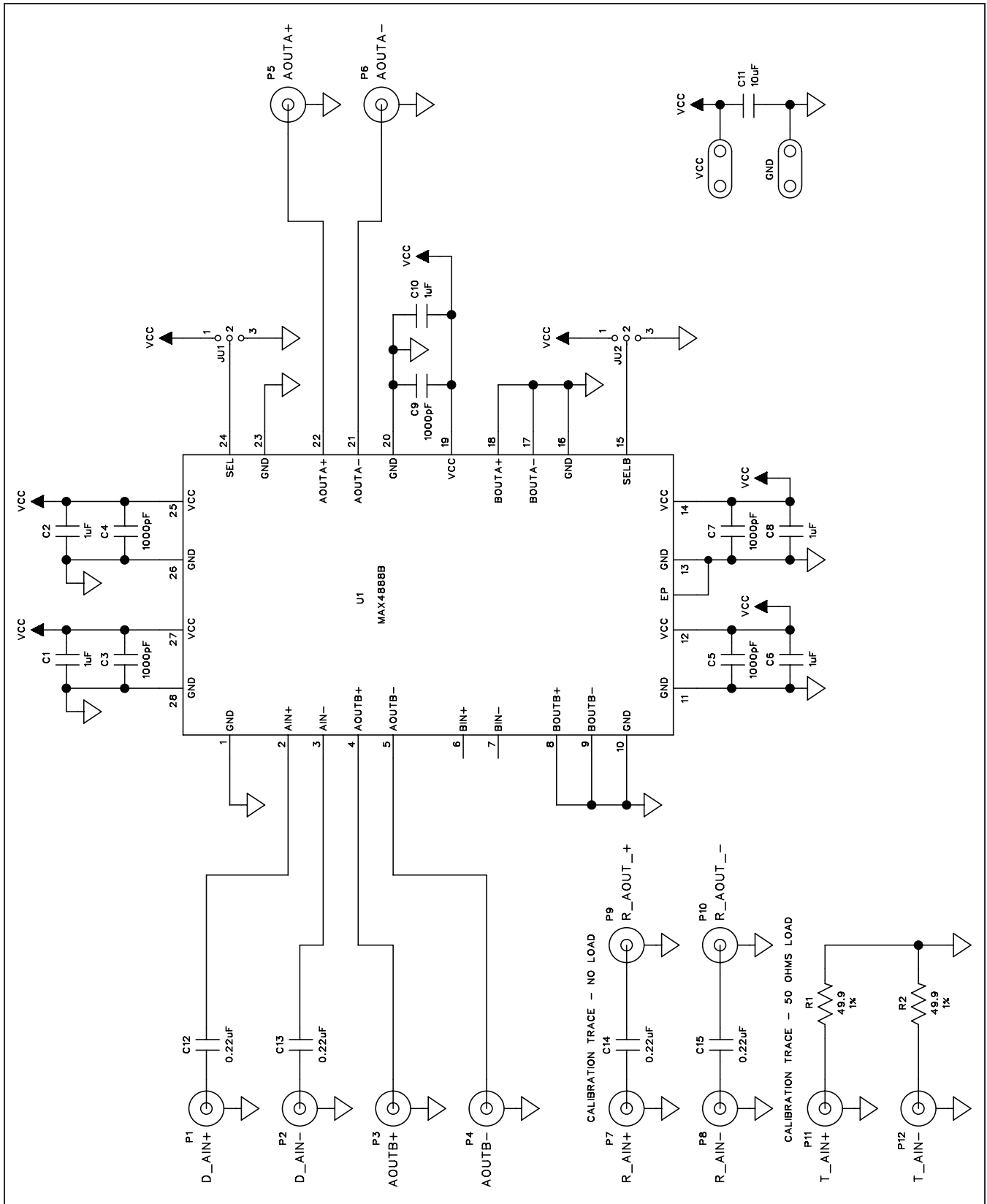

Figure 1. MAX4888B EV Kit Schematic

MAX4888B Evaluation Kit

Evaluates: MAX4888B

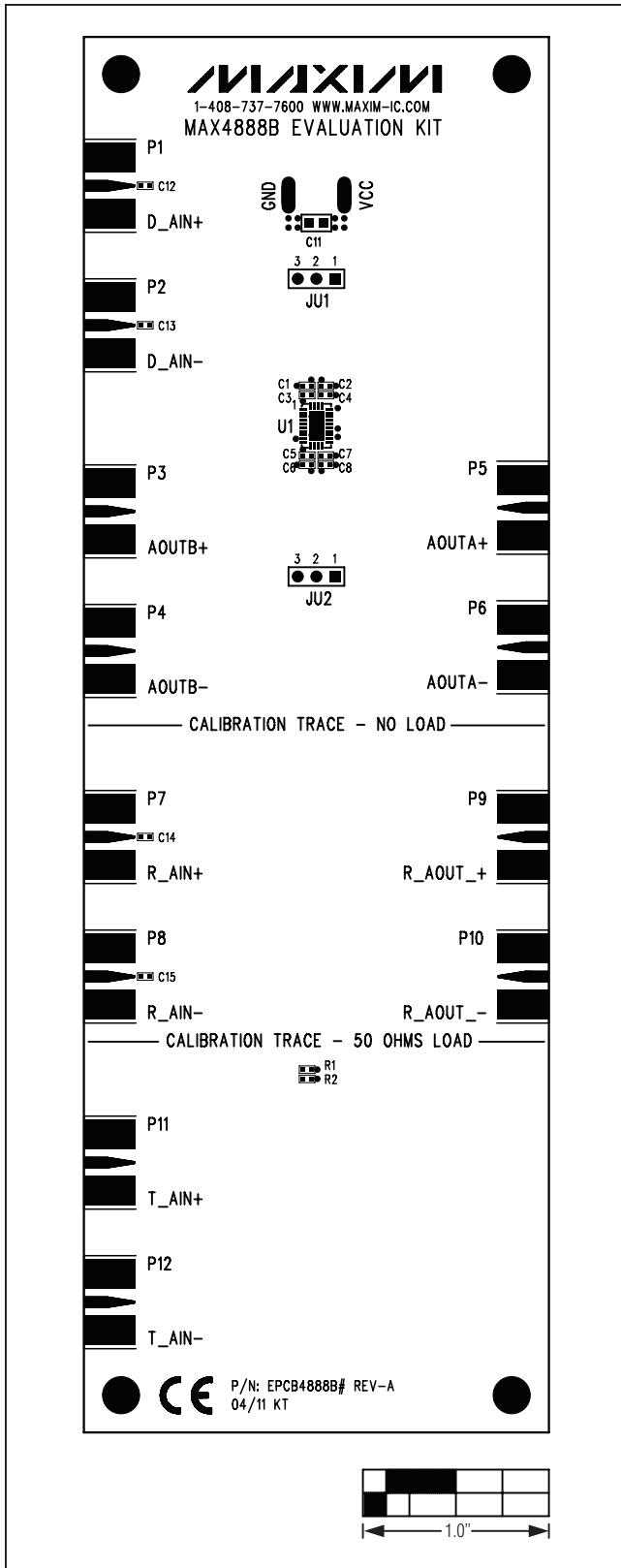

Figure 2. MAX4888B EV Kit Component Placement Guide—Component Side

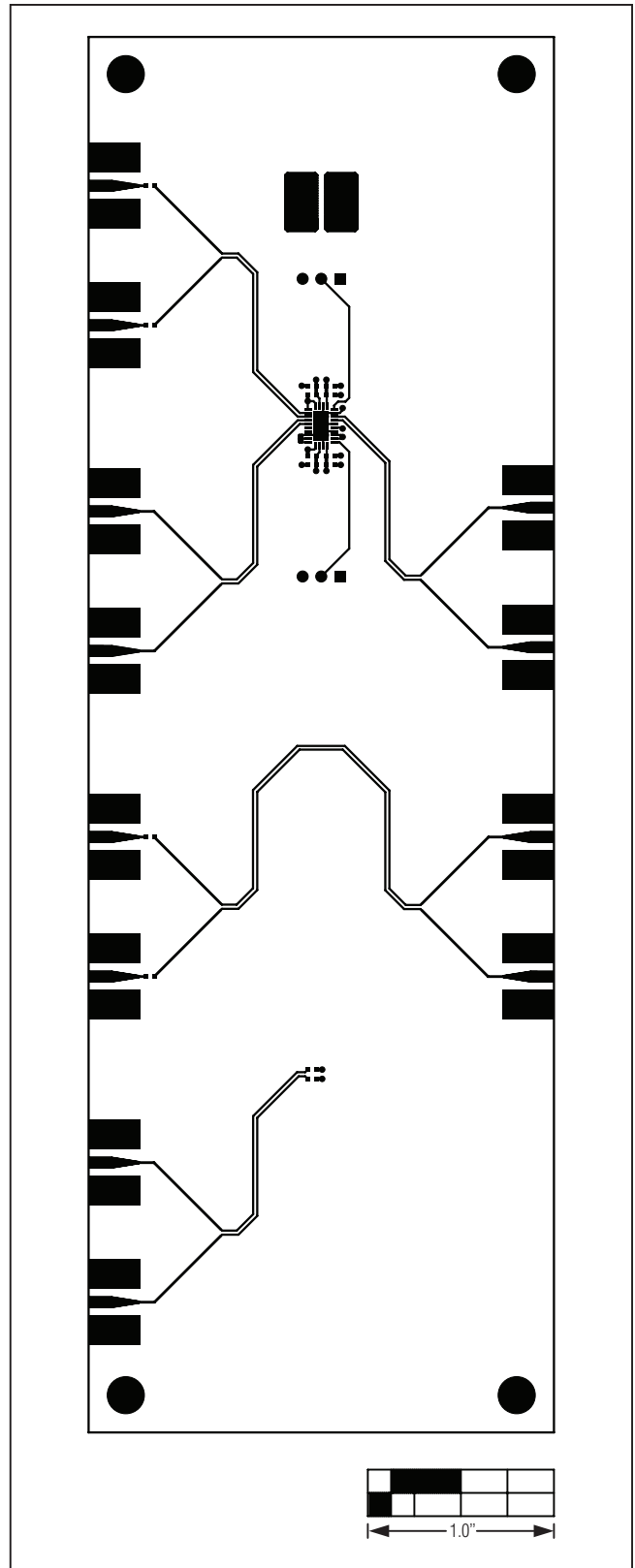

Figure 3. MAX4888B EV Kit PCB Layout—Component Side

MAX4888B Evaluation Kit

Evaluates: MAX4888B

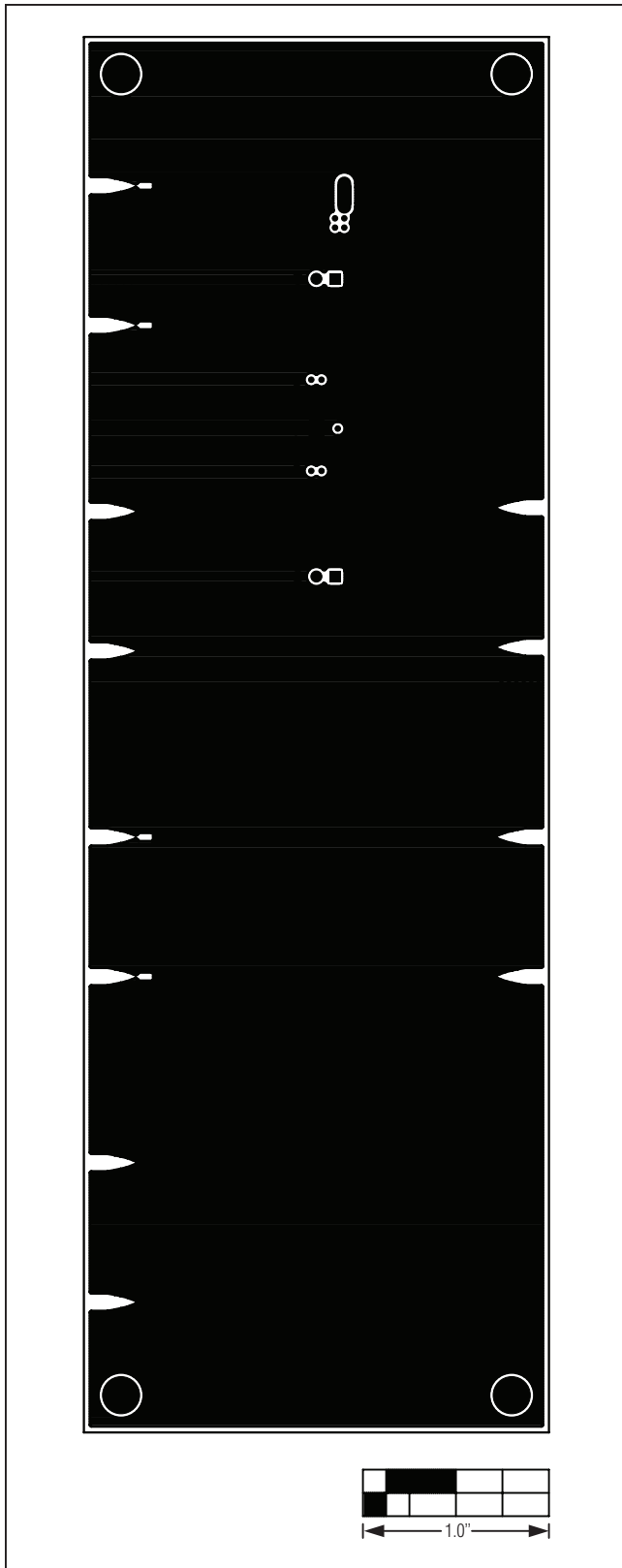

Figure 4. MAX4888B EV Kit PCB Layout—Inner Layer 2

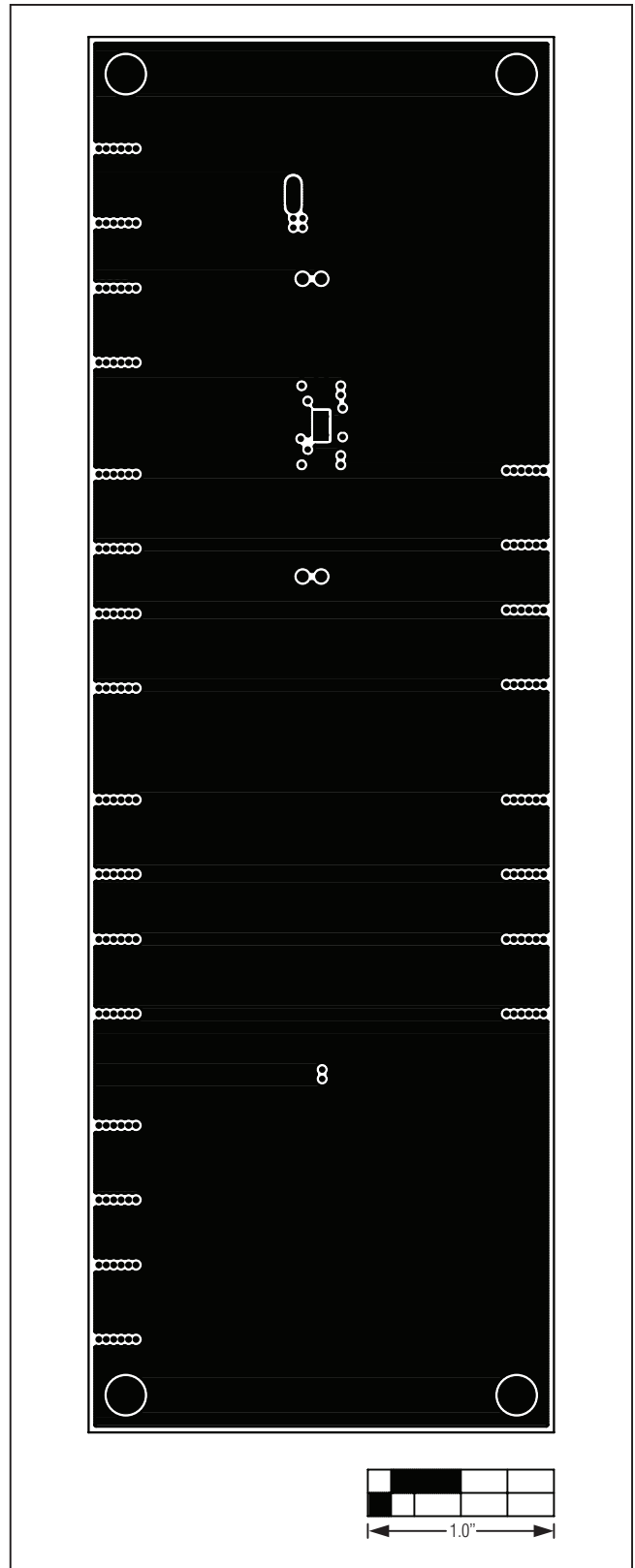

Figure 5. MAX4888B EV Kit PCB Layout—Inner Layer 3

MAX488B Evaluation Kit

Evaluates: MAX488B

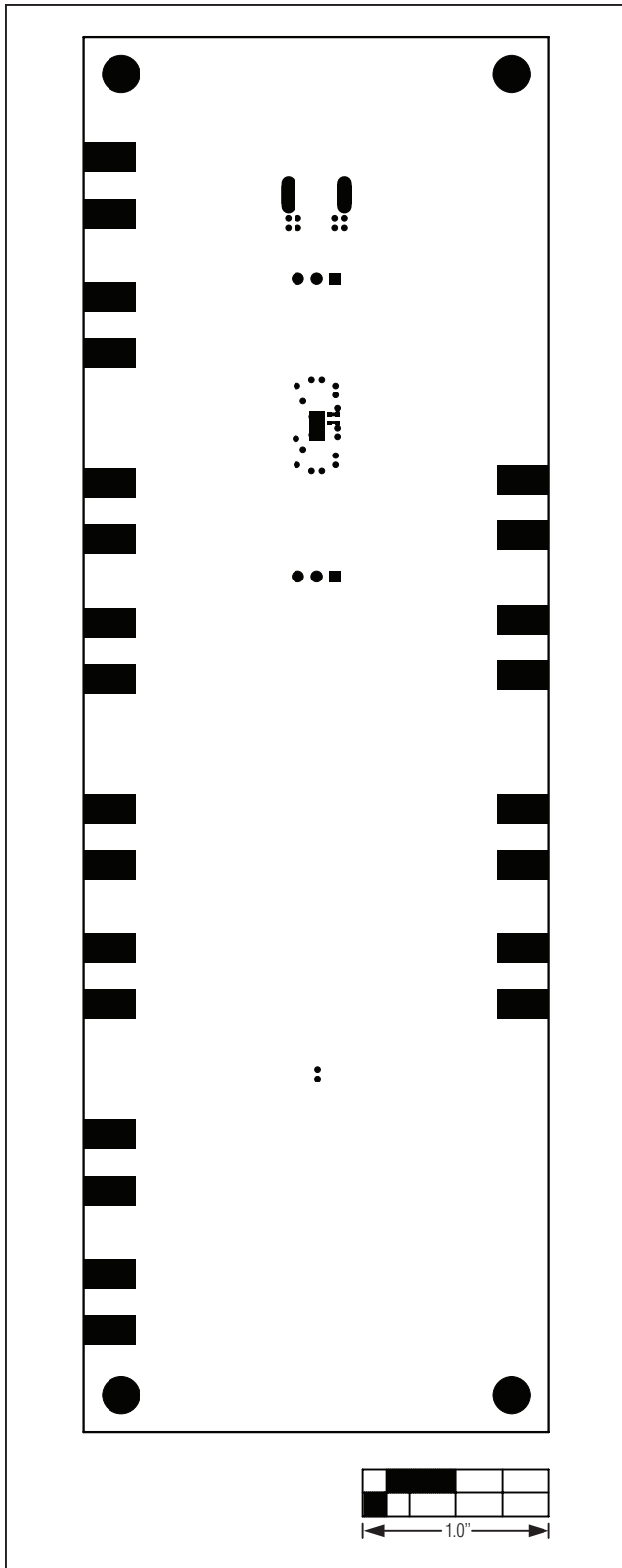

Figure 6. MAX4888B EV Kit PCB Layout—Solder Side

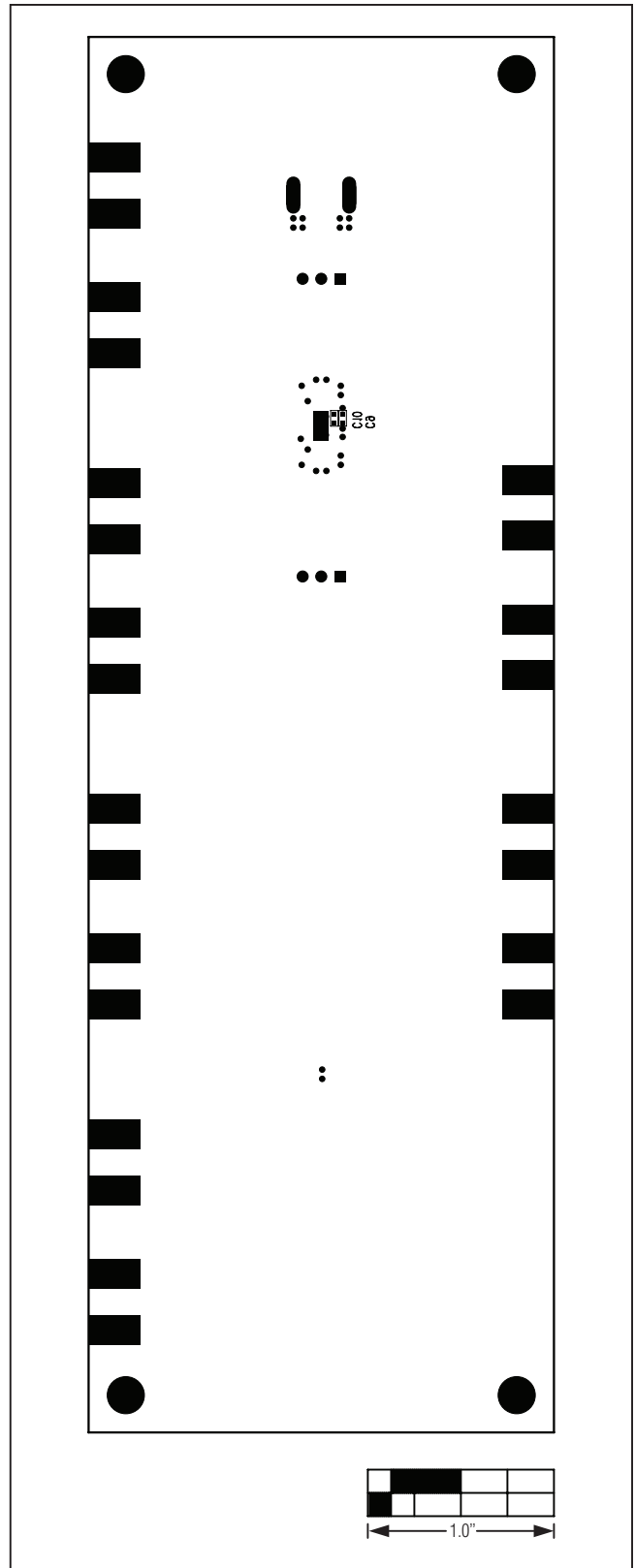

Figure 7. MAX4888B EV Kit Component Placement Guide—Solder Side

MAX4888B Evaluation Kit

Evaluates: MAX4888B

Ordering Information

PART	TYPE
MAX4888BEVKIT#	EV Kit

#Denotes RoHS compliant.

MAX4888B Evaluation Kit

Evaluates: MAX4888B

Revision History

REVISION NUMBER	REVISION DATE	DESCRIPTION	PAGES CHANGED
0	5/11	Initial release	—

Maxim cannot assume responsibility for use of any circuitry other than circuitry entirely embodied in a Maxim product. No circuit patent licenses are implied. Maxim reserves the right to change the circuitry and specifications without notice at any time.

Maxim Integrated Products, 120 San Gabriel Drive, Sunnyvale, CA 94086 408-737-7600 _____ 9